

CBSE AFFILIATION NO-3330131

SANSKAR PUBLIC SCHOOL

Identity Through Education

KABIR CHOWK, ODISHA ROAD, RAIGARH (C.G.)



CLASS - UKG

Summer Assignment



- This booklet contains 18 Pages.
- Parents will make a booklet of Assignments given on Page no -1 to 18.
- We expect creativity from our students in completing these Assignment.
- Parents are requested to help them and make completion of these assignment a fun task for them.
- Student will either take a print out or do it on A-4 size paper with the help of their parents.

ENGLISH

1

All About Me

My Name is _____

Colour it

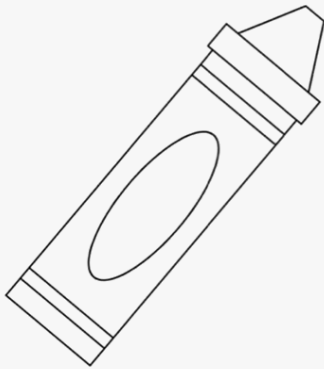

My favorite color is _____.



I am _____ Years old

I am a

Girl

Boy



My Favorite Fruit is _____



My Favorite Food is _____



Fill in the Missing Uppercase Letters

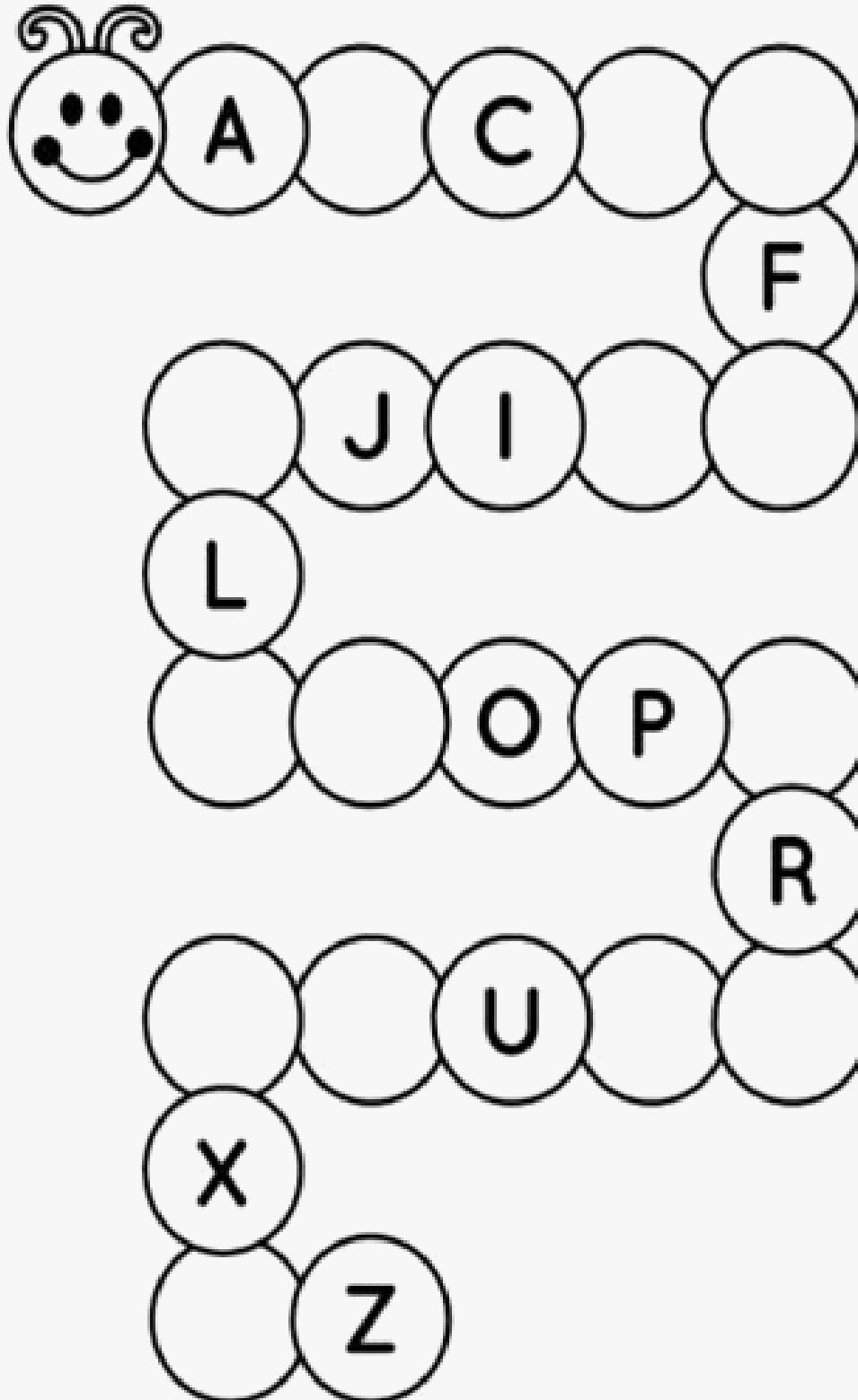

Fill in the Missing Lowercase Letters



a

c

e

j

g

m

p

r

w

u

y



Match the uppercase letter to its lowercase.



A



C



E



G



I



L



K



M



B



D



O

d

m

b

e

c

k

a

o

g

l

i

Match the uppercase letter to its lowercase.



Sun

S



Z



Tap

T



W



Umbrella

U



t



Van

V



v



Worm

W



S



X-mas

X



x



Yak

Y



u



Zebra

Z



y

HINDI

6

1 **स्वर** – खाली स्थान में सही वर्ण भरो –

— आ, — ई, — ऊ, — ऐ — औ — अं — ।

2 **व्यंजन** – खाली स्थान में चित्र देखकर सही वर्ण भरो



क	—	ग	—	ङ
—	छ	—	झ	ञ
—	ठ	ड	—	ण
त	थ	—	ध	—
प	—	ब	भ	—
य	र	—	—	
श	—	स	—	



चित्र देखकर पहला अक्षर लिखे और रंग भरो



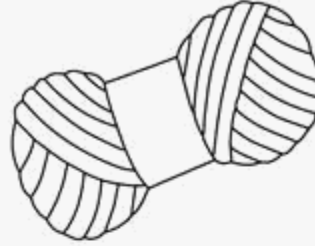

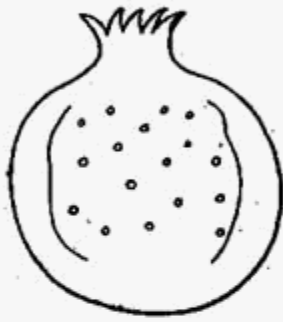



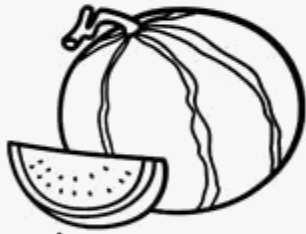





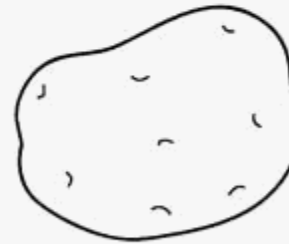



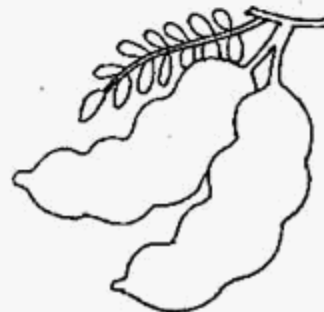

3. चित्र देखकर सही शब्द पर गोला लगाइए।



कप

फल

मटर



शरबत

अदरक

नटखट



कप

फल

कलश



नयन

अदरक

बरगद



मटर

कलम

पवन



बस

फल

सड़क



घर

फल

नल

तीन अक्षर वाले शब्दों का अभ्यास करें

ब + ह + न =

प + ह + न =

स + ह + न =

ब + द + न =

म + द + न =

भ + ज + न =

प + व + न =

न + य + न =

अ + ग + र =

म + ग + र =

MATHS

Write Number Names

1		11	
2		12	
3		13	
4		14	
5		15	
6		16	
7		17	
8		18	
9		19	
10		20	

Write the missing numbers.

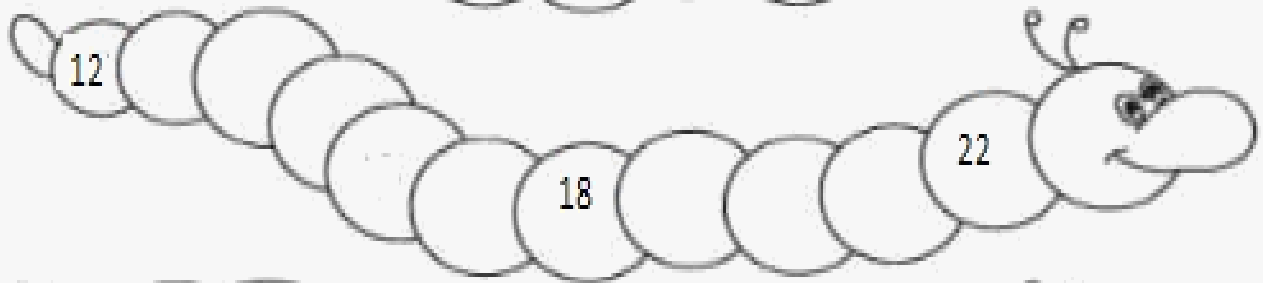
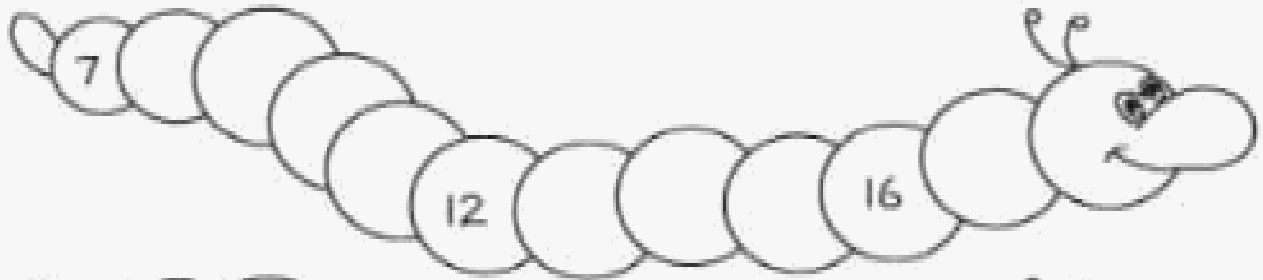

Colour these Tree.



How many Trees are there ?

Count the number of objects in each set and put a tick mark next to the set with 6 objects.



Write missing letter of fruits name.



_ p p l _



g r _ p _



b _ n _ n _



b _ r r y



p l _ m



_ r _ n g _



l _ m _ n



ch _ r r y



k _ w _



p _ _ r

How many of the following do we have?























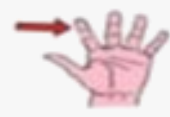

Fruits & Vegetables

A. Cross (X) the odd one out.

1.



2.



3.



4.



5.



6.



Vegetables

Vegetables make us fit and healthy.

Look at the picture and write their name and colour them.

















DRAWING

Use number counting from 1 to 8 and make a Drawing
Best brain development activity

https://youtu.be/2LU4iXP0_Ug

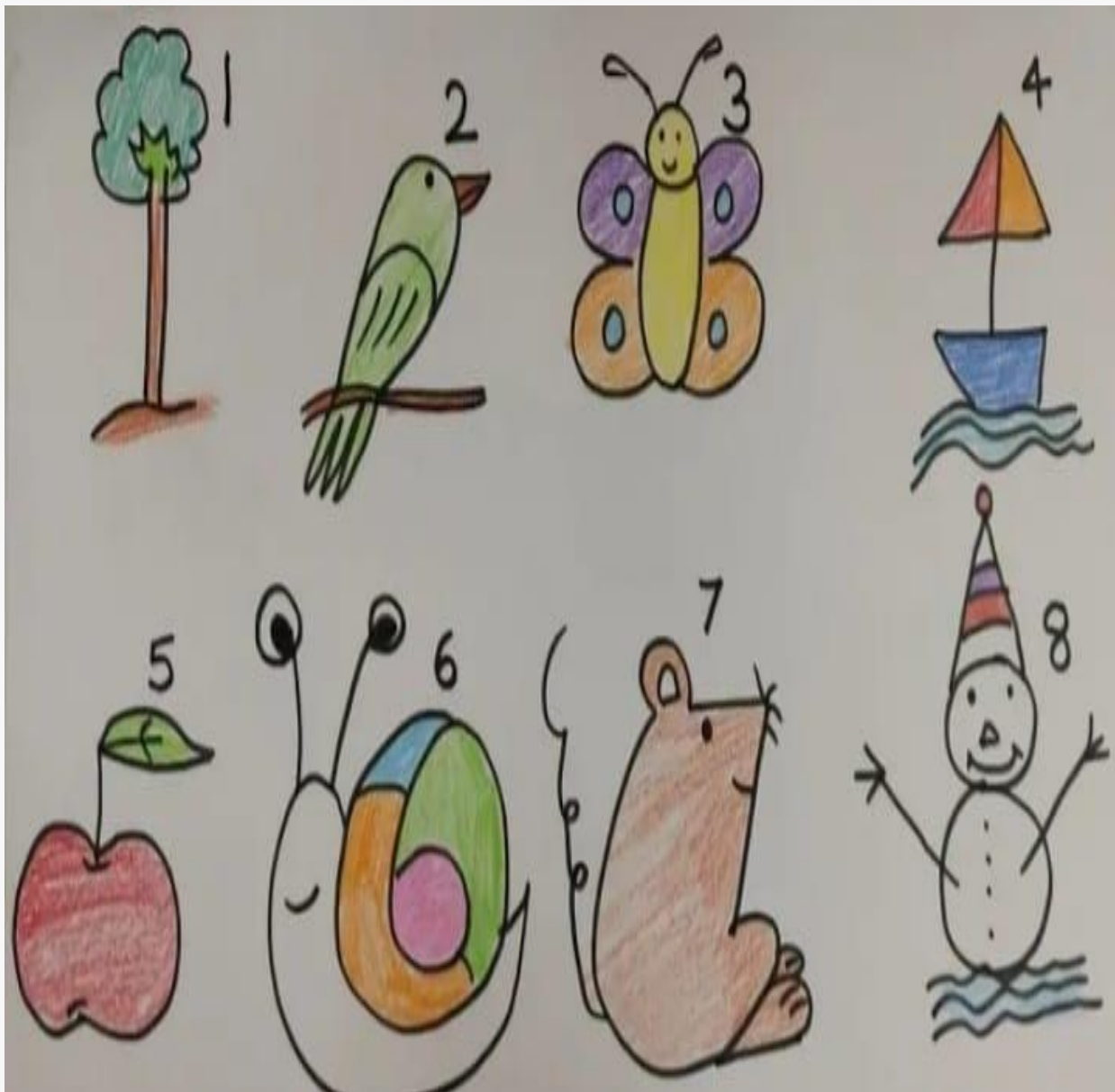

ART & CRAFT

Use different types of colourful paper and make a craft.

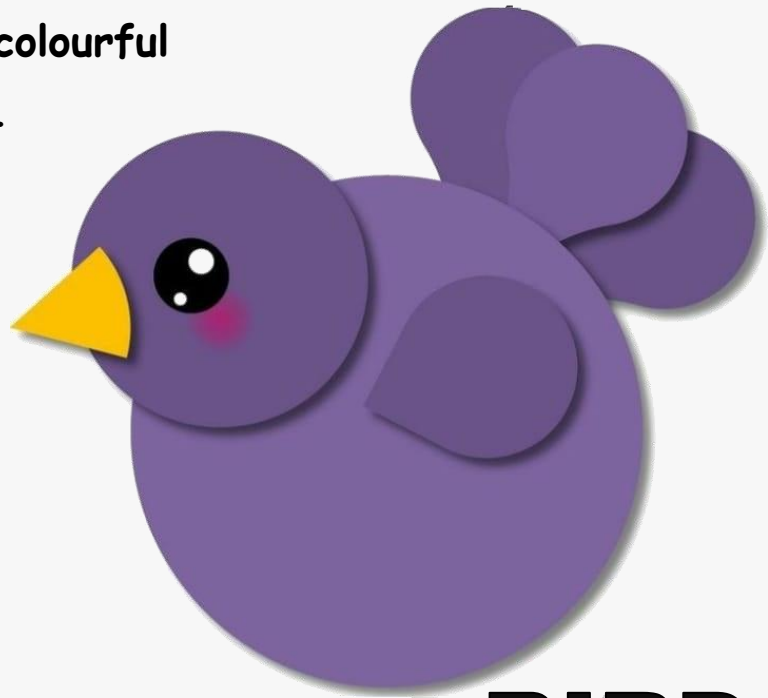

BIRD



DOLL

Use different types of colourful paper and make a shapes craft.





LIFE SKILL ACTIVITY

Dear Students

Practice these TEN Skills everyday during your vacation.

- ☑ SELF CARE
- ☑ REGULAR EXERCISE
- ☑ MAINTAIN GOOD HEALTH AND HYGIENE
- ☑ WATER PLANTS
- ☑ DO RELIGIOUS PRACTICES
- ☑ LEARN MORAL VALUES
- ☑ HELP YOUR MOTHER IN KITCHEN AND HOUSEHOLD WORK
- ☑ SPEND TIME WITH ELDERS
- ☑ LEARN SOMETHING NEW YOU ARE INTERESTED IN
- ☑ TAKE CARE OF YOUR PETS





Thank You

**SPS Management
appreciate your efforts**